

PREINSTALLATION  
VORINSTALLATION

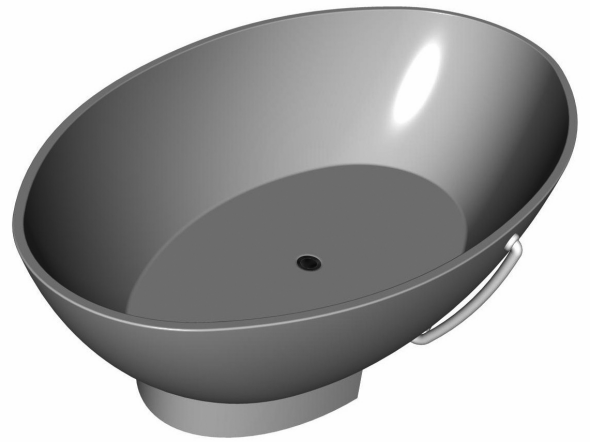
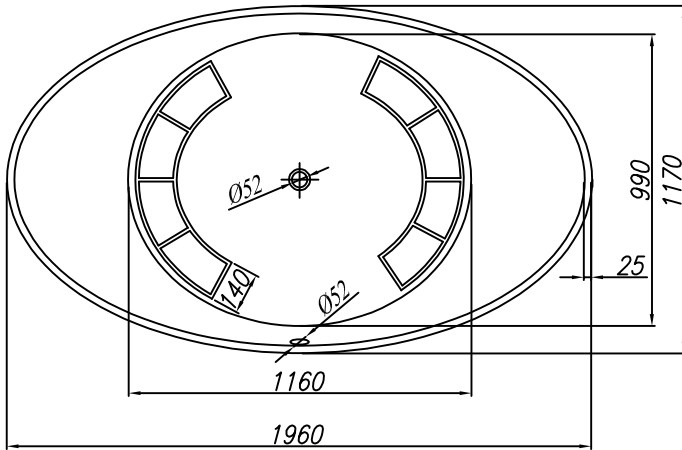
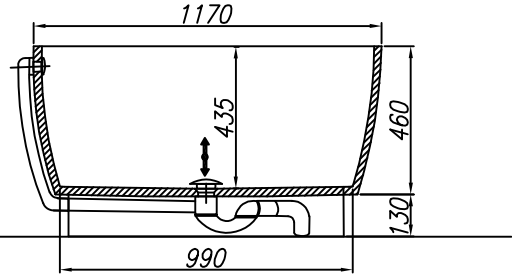
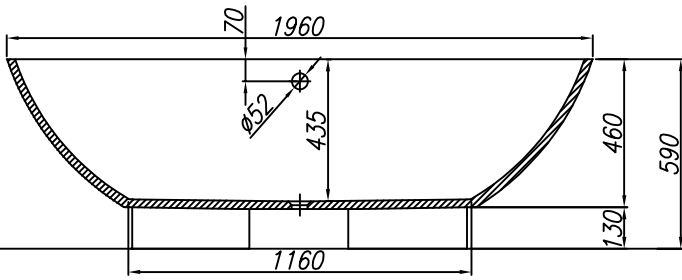

VOLUME (l)  
VOLUMEN (l)

MAX. LOAD (kg)  
MAX. BELASTUNG (kg)

FLOOR LOAD (kg/m<sup>2</sup>)  
BODENBELASTUNG (kg/m<sup>2</sup>)

470

800

720

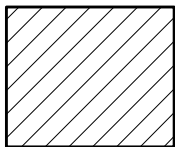

- Drain spot Ø 50mm
- Abflussplatz Ø 50 mm

INSTALLATION RECOMMENDATION  
MONTAGEEMPFEHLUNG

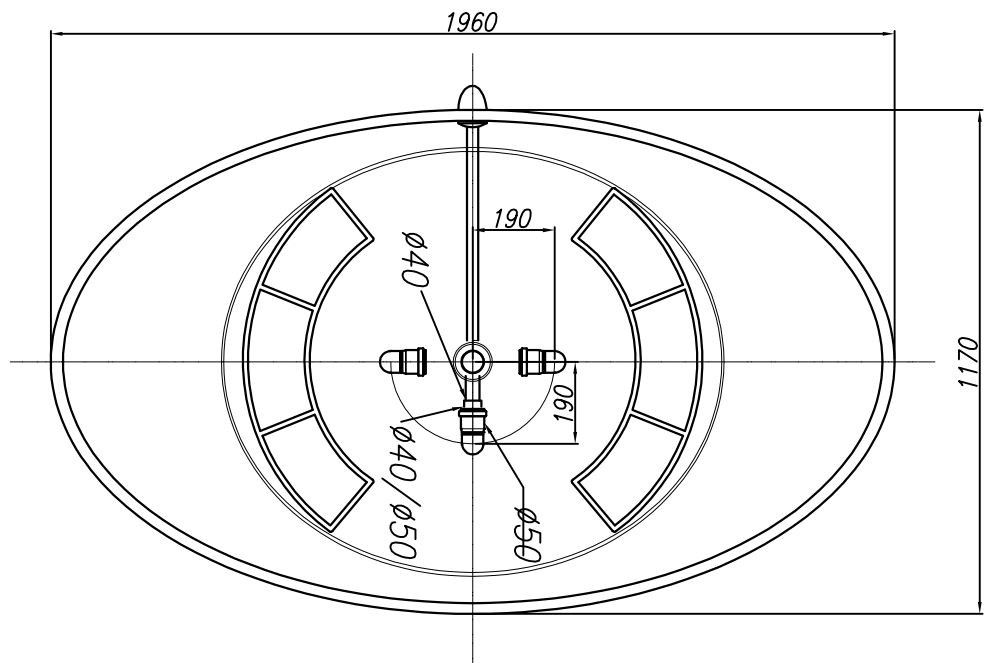

Bathtub from KERROCK  
Badewanne aus KERROCK